

Project is funded by the Croatian Science Foundation, project number IP-2018-01-4108

Correlation of optical and electrical measurements of the delayed discharge propagation in GEM detectors

Antonija Utrobičić, Marinko Kovačić, Mirko Planinić, Filip Erhardt,
Nikola Poljak and Marko Jerčić

University of Zagreb

MPGD conference 2019, La Rochelle (France)

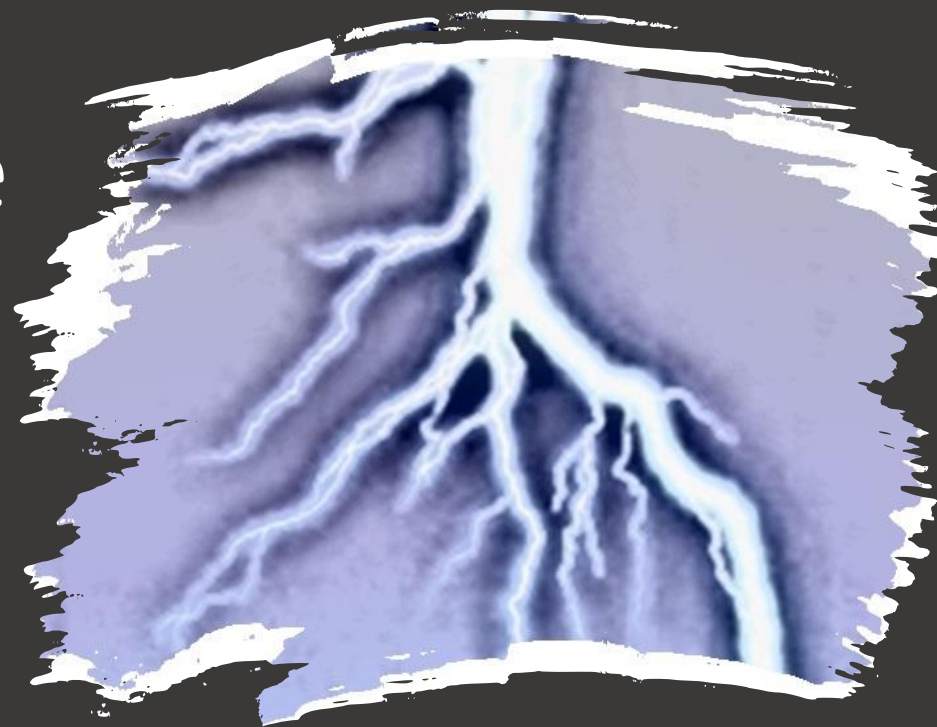

Delayed discharge propagation (DP) to the readout electrode

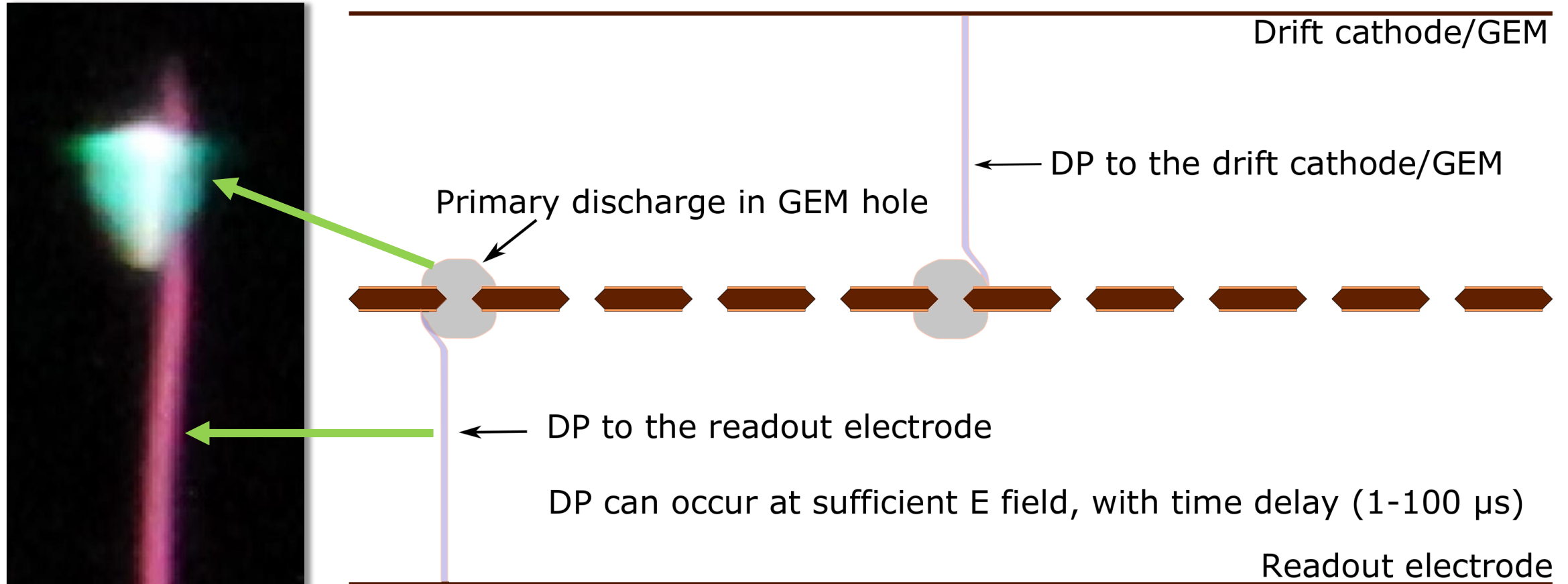

- DP to the readout electrode: dangerous -> can destroy electronics.
- Motivation: understand the physical mechanism of the delayed DP.

Design and development of experimental setup for DP measurements

- **Transparent chamber:**

- 15 mm thick acrylic glass (Plexiglass)
- M3 brass inserts were used to enable more disassembly/assembly cycles.

- **Custom made HV bandwidth scope probe:**

- combination of commercial LeCroy (500 MHz, 10x) probe and custom build coaxial capacitor divider.
- capacitive divider is made of coaxial PTFE 2 pF capacitor and 100 pF/1 kV capacitor that was in parallel to the 10x probe input. Total ratio of 500x has been realized.

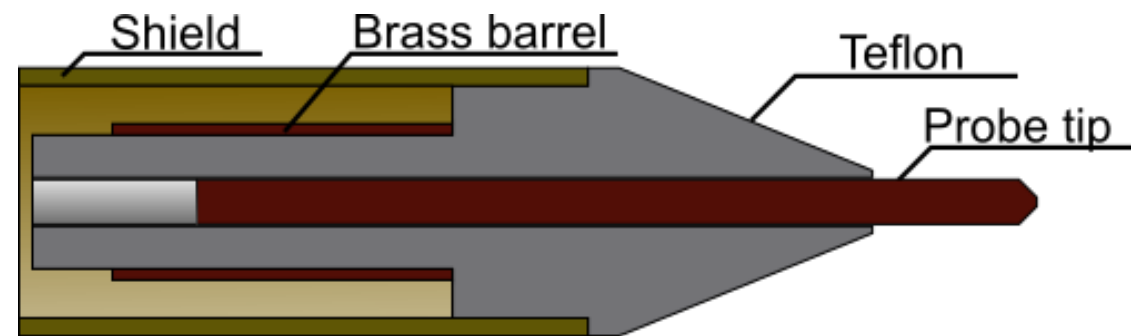
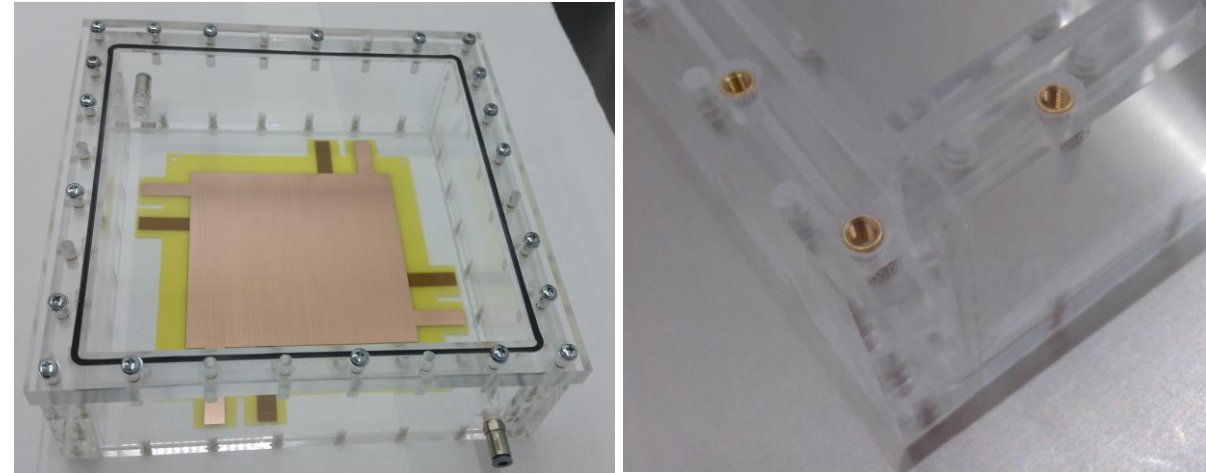

Design and development of experimental setup for DP measurements

- **Single hole THGEM foil:**
 - 0.2 mm thick FR4 dielectric material covered on both sides with 17.5 μm copper layer and single hole $\phi=0.3$ mm.
 - 100 x 100 mm²

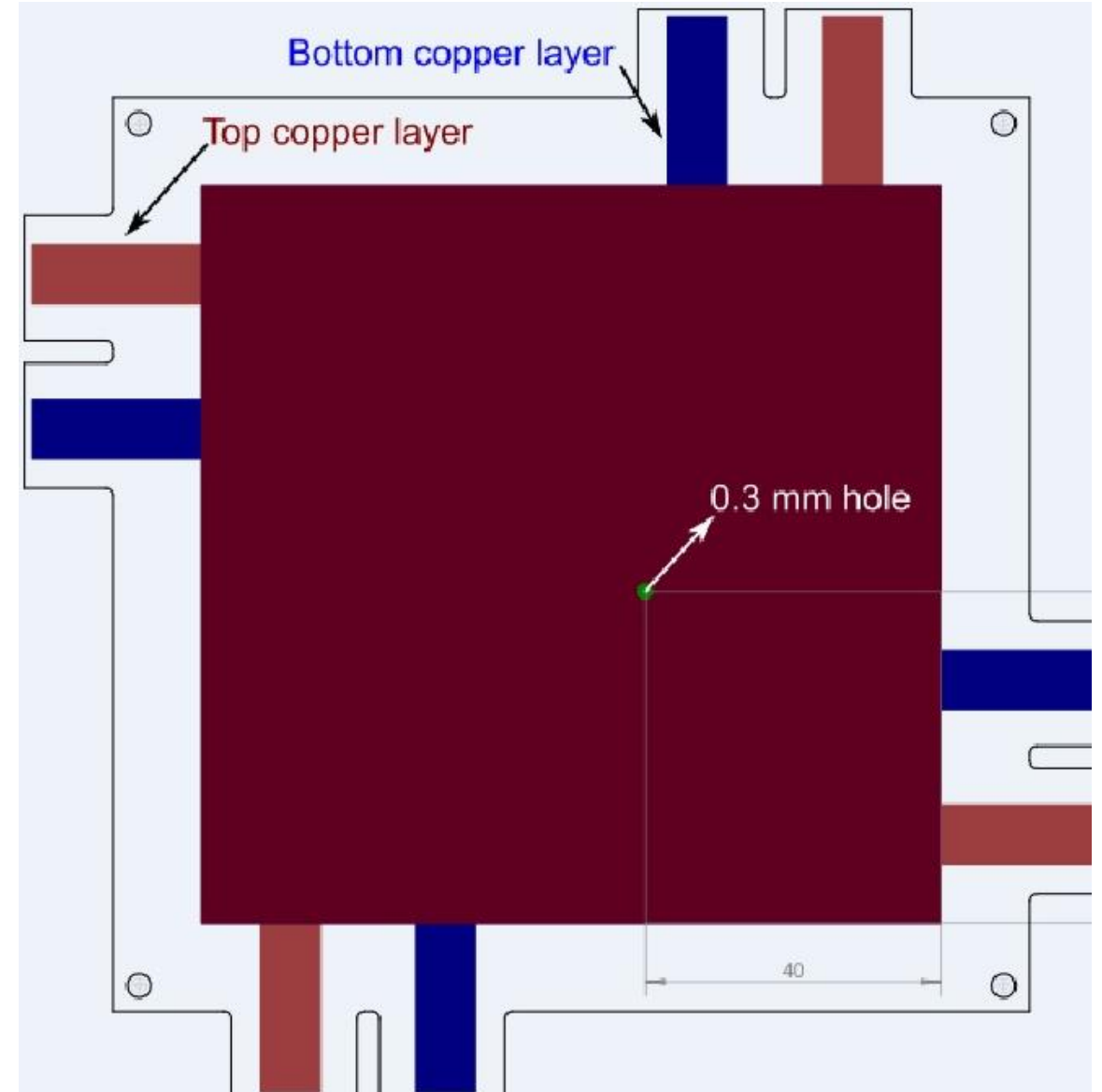

Experimental setup

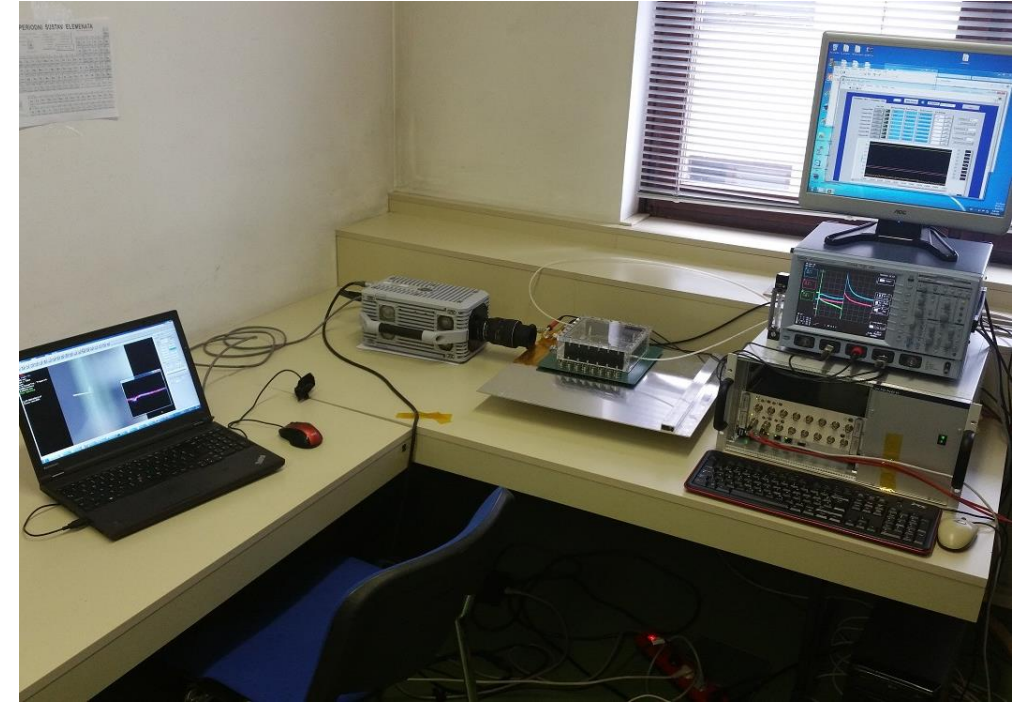
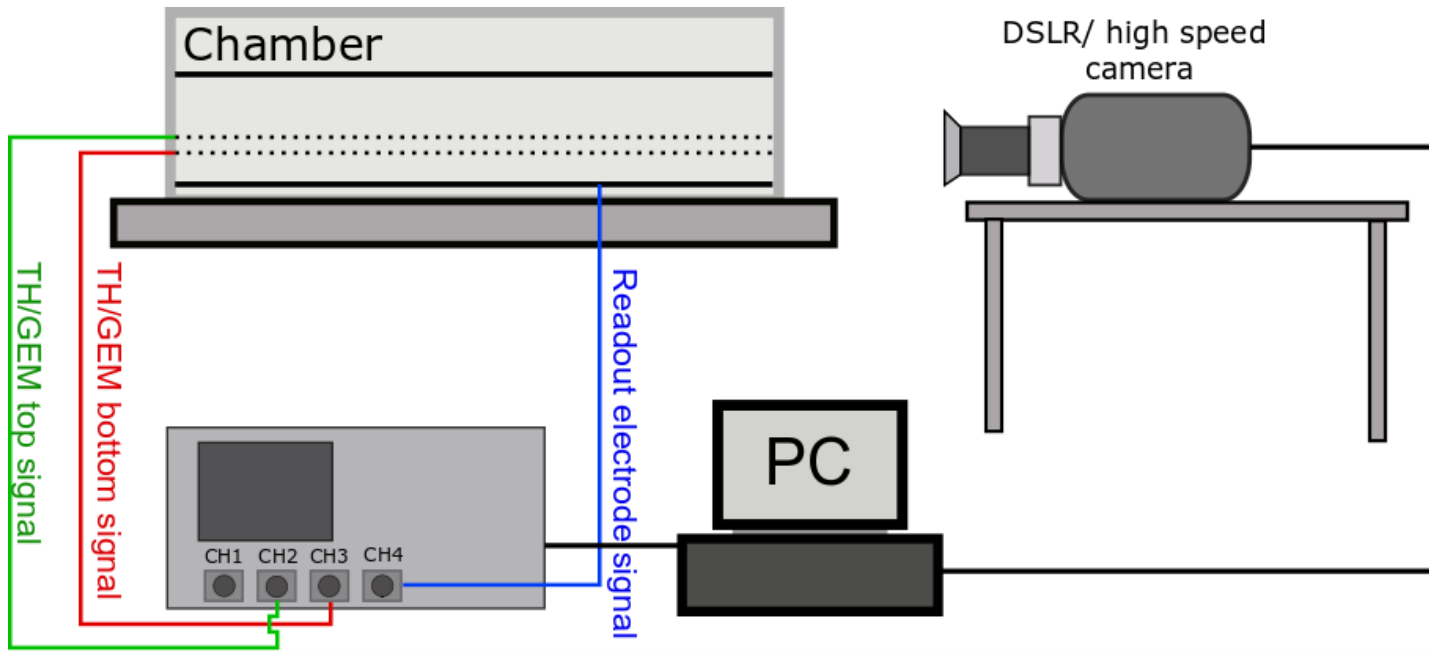

- Signals were recorded with an oscilloscope and transferred to the PC.
- Data from the scope and digital camera were recorded simultaneously to correlate the electrical measurements with optical.

Powering schematics

- Large loading resistor (500 MΩ) used to limit the sparking rate (for the THGEM).

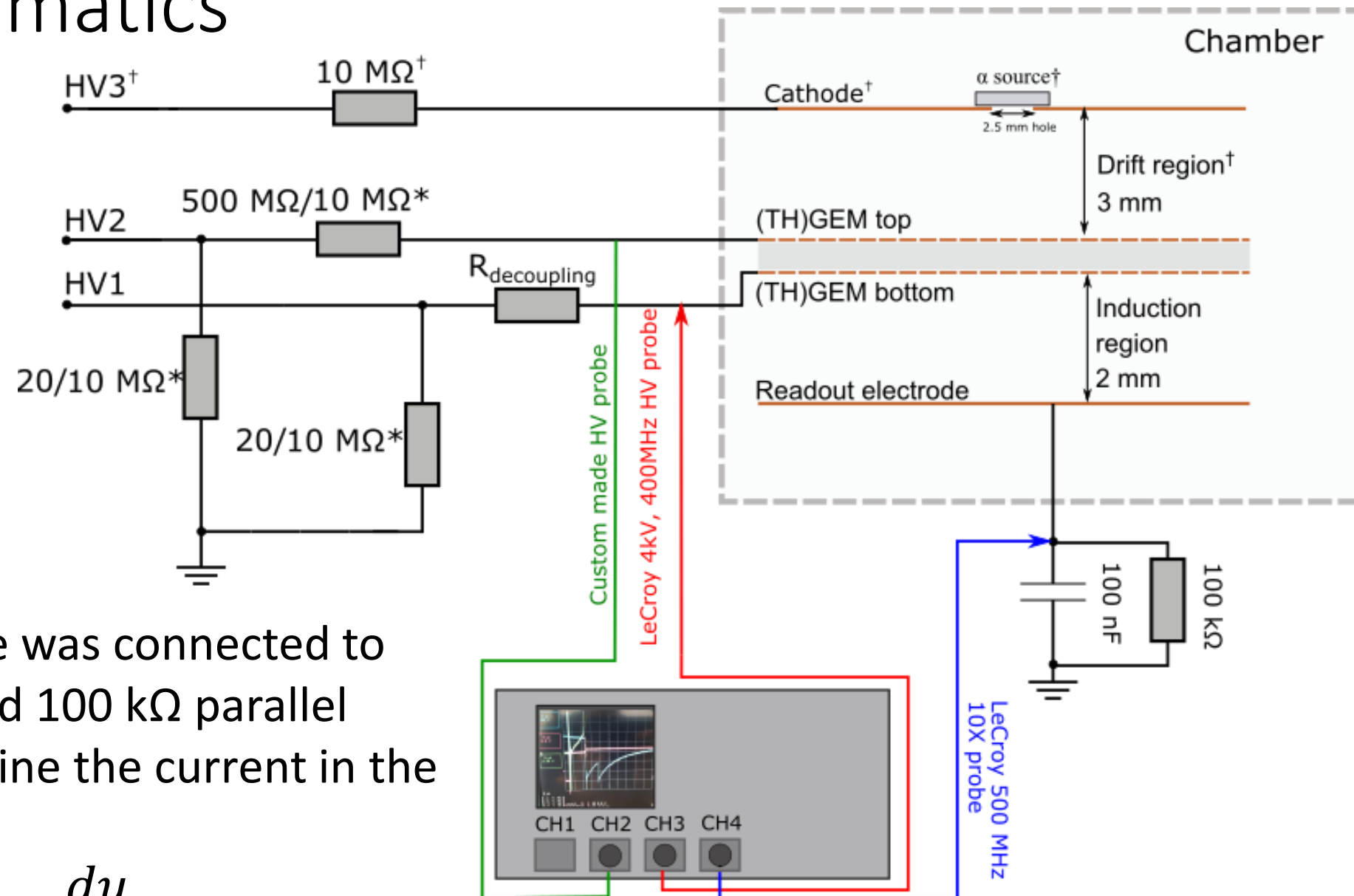

- The readout electrode was connected to GND over a 100 nF and 100 kΩ parallel connection to determine the current in the induction region.

$$i(t) = C \frac{du}{dt}$$

Single hole THGEM delayed DP waveforms

$E_{\text{ind}} = 4.00 \text{ kV/cm}$, THGEM foil

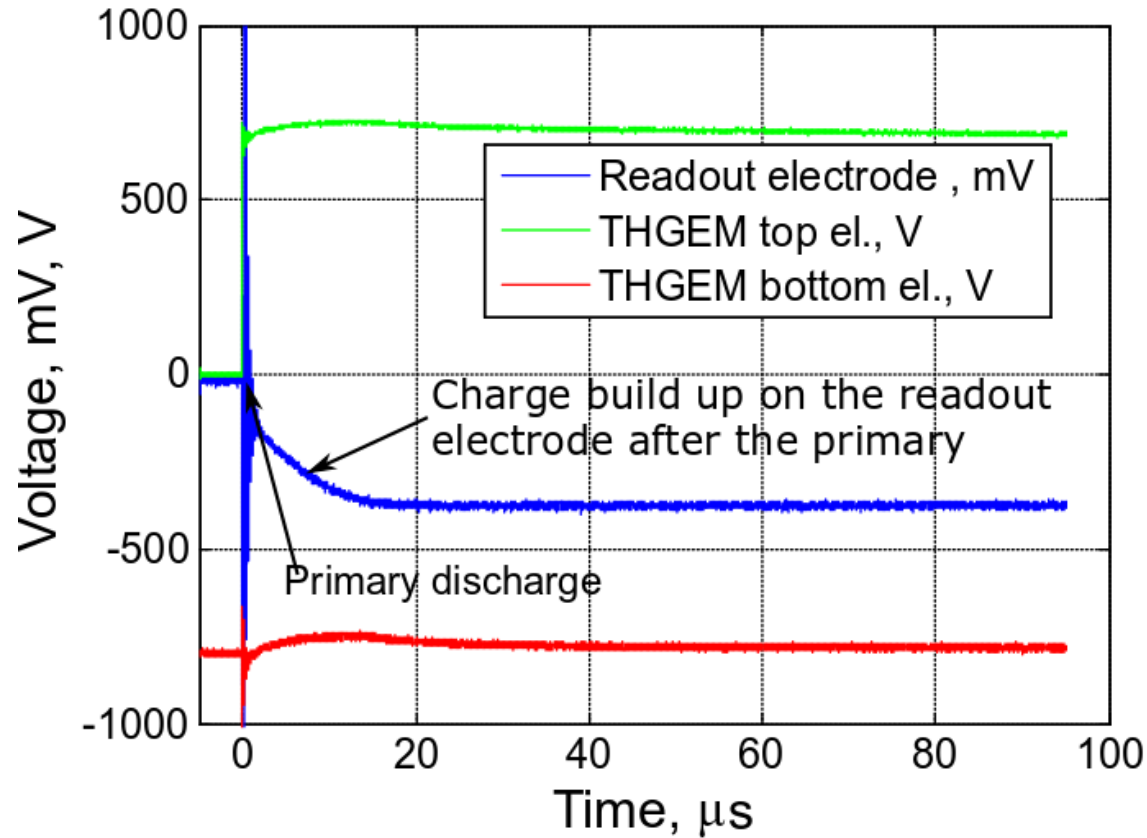

$E_{\text{ind}} = 5.38 \text{ kV/cm}$, THGEM foil

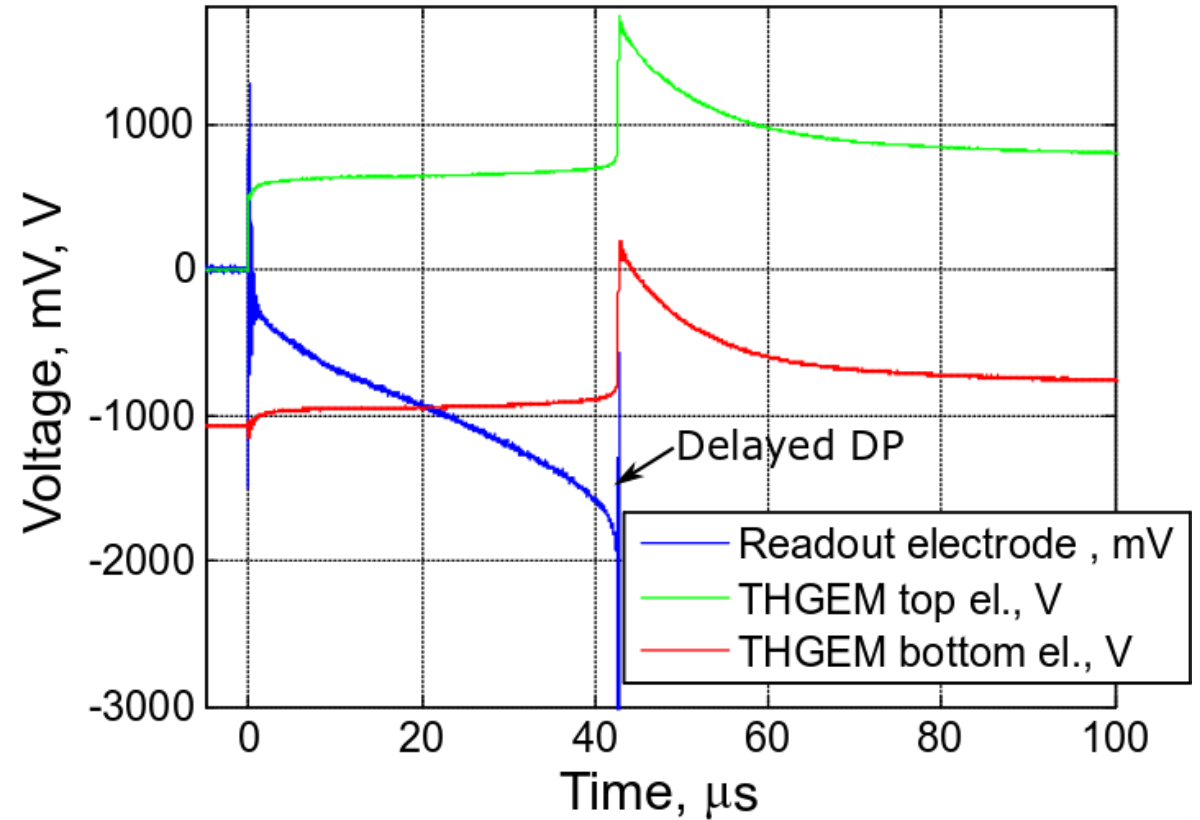

- Following the primary discharge, charge flows in the induction region for $\sim 15 \mu\text{s}$.
- Charge build-up increases with the induction field. (4 kV/cm field)
- A constant slope in the charge build-up precedes the DP event.
- This can indicate that the charge transfer (current) is responsible for the DP.

Charge build up on the readout electrode

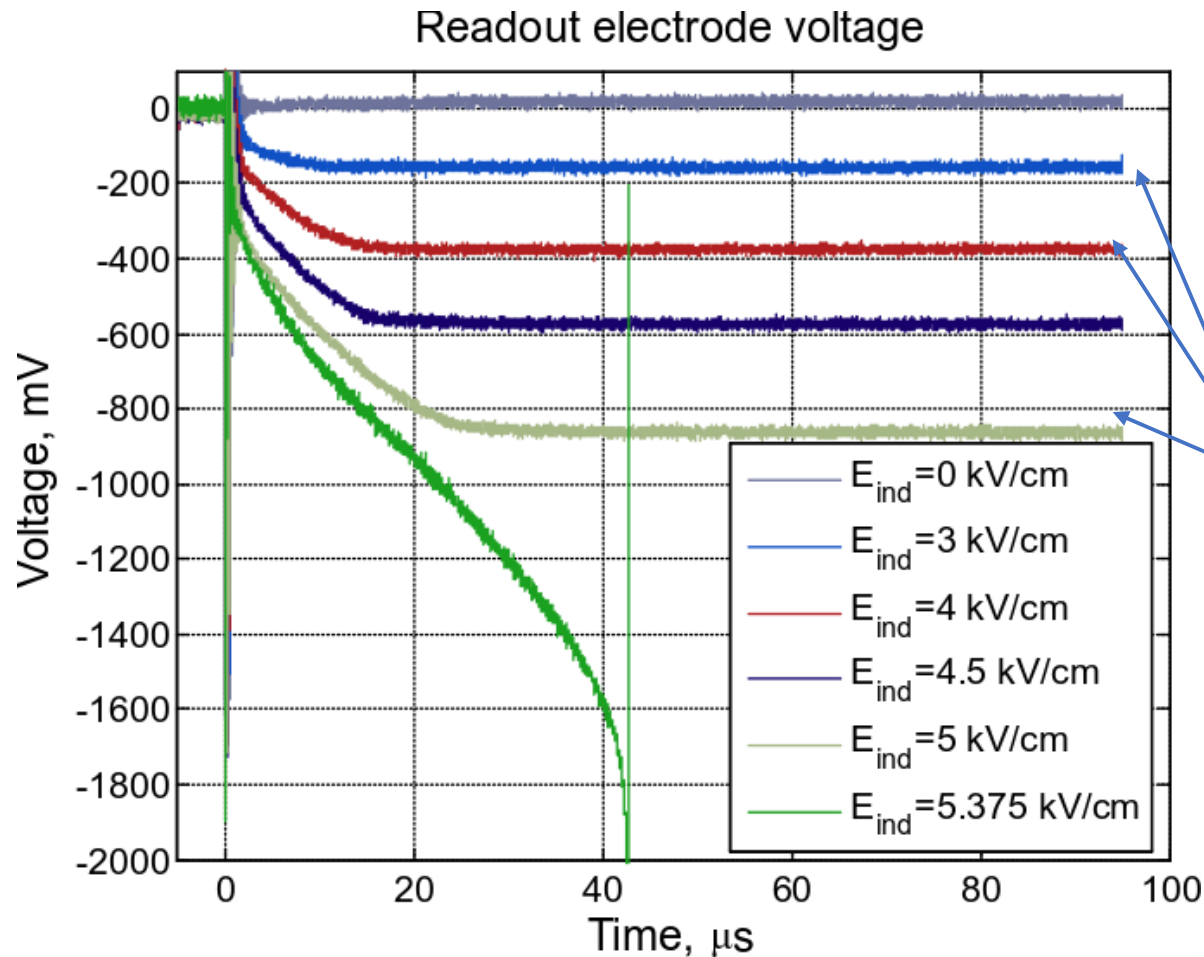

- Current in the induction region causes charge build-up on the readout electrode capacitor.
- $Q = Cu \rightarrow i(t) = \frac{dQ}{dt} = C \frac{du}{dt}$
- Smooth fit needed for a derivable signal
- No DP: Higher order exponential fit:
$$u(t) = \sum_{i=1}^n k_i (1 - e^{-\frac{t}{\tau_i}})$$
- DP: Spline fit
- Analytic derivation of the fit gives the current.

Current in the induction region (THGEM)

- For no DP events: current decays to zero within $\sim 10 - 20 \mu s$.
- For DP events: current in the induction region reaches the minimum value in mA range.
- Minimal current is almost constant what indicates formation of some form of sustained discharge.
- The current rise is followed by the DP to the readout board.

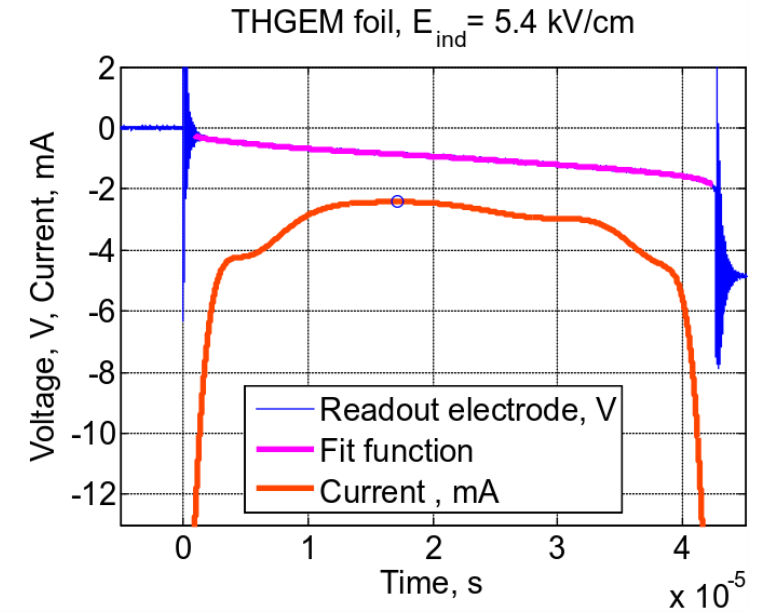
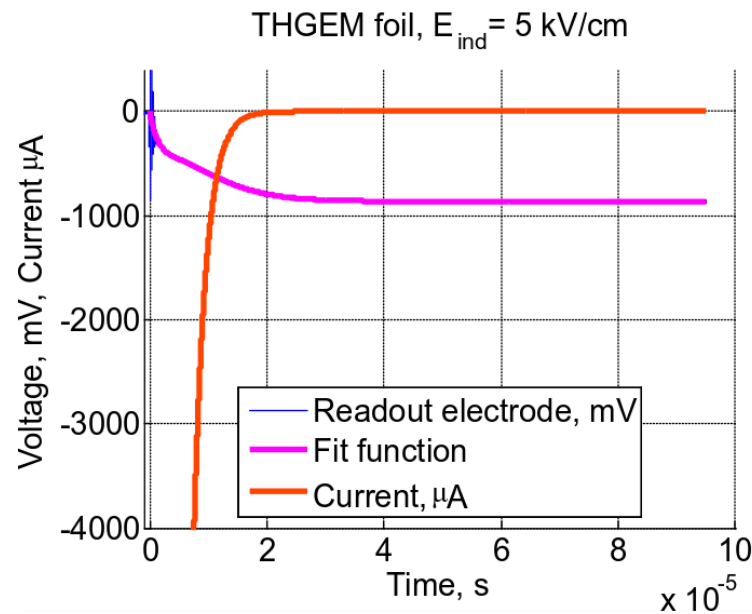
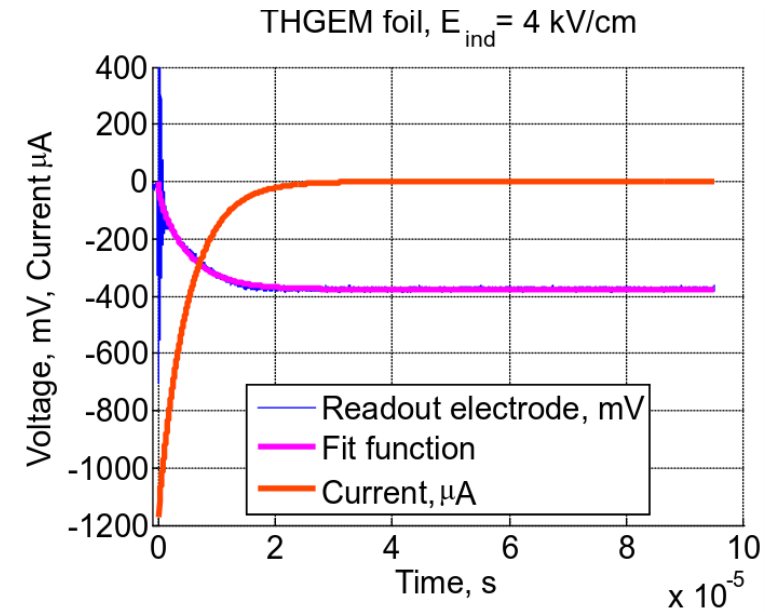
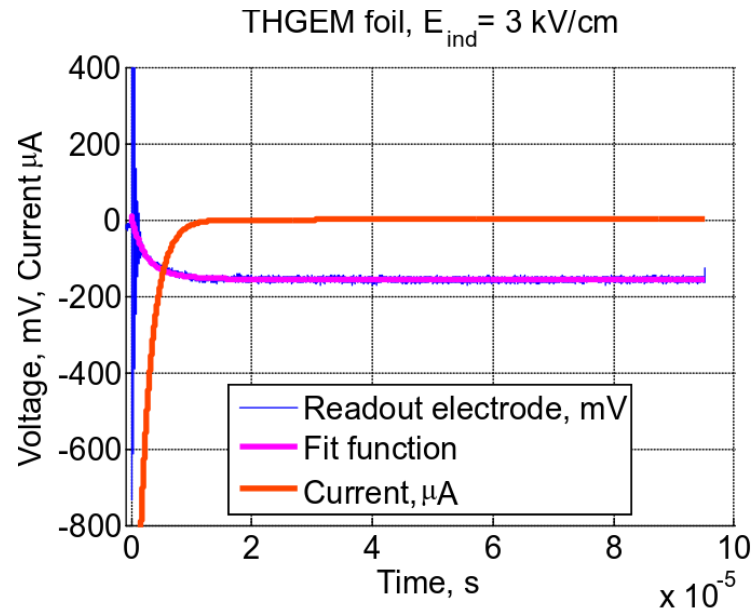

GEM delayed DP waveforms and the readout electrode charge build up

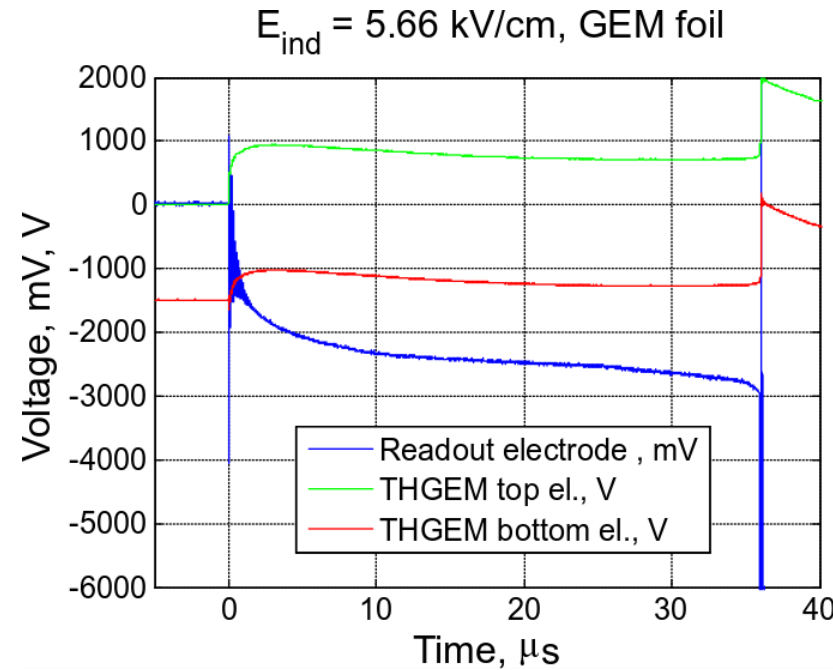
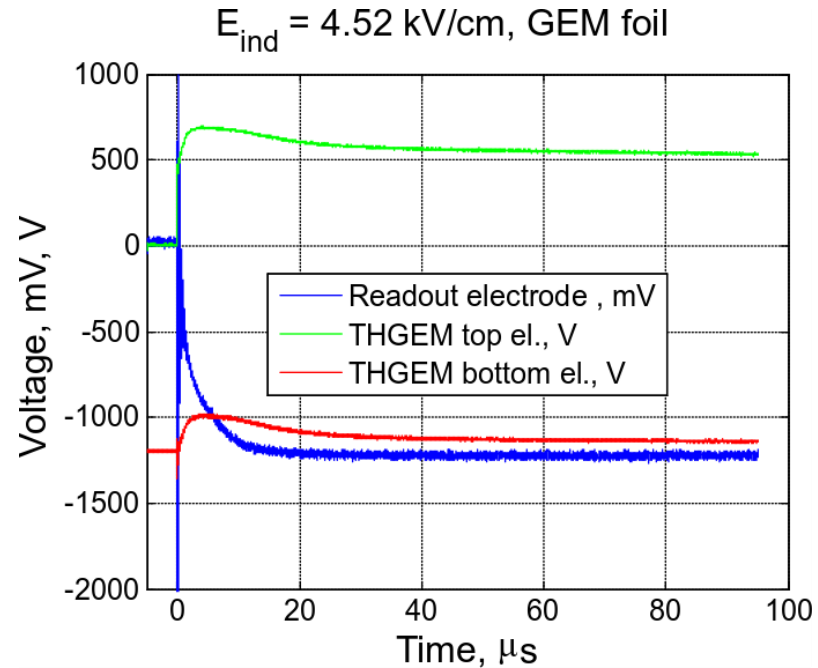

- Single stage GEM detector (LP GEM foil) used to validate THGEM usage.
- Readout electrode charge build-up observed similar to THGEM measurements.
- This suggests that event at moderately low induction fields there is initial current through the induction region right after the primary that decays with time.

Current in the induction region (GEM)

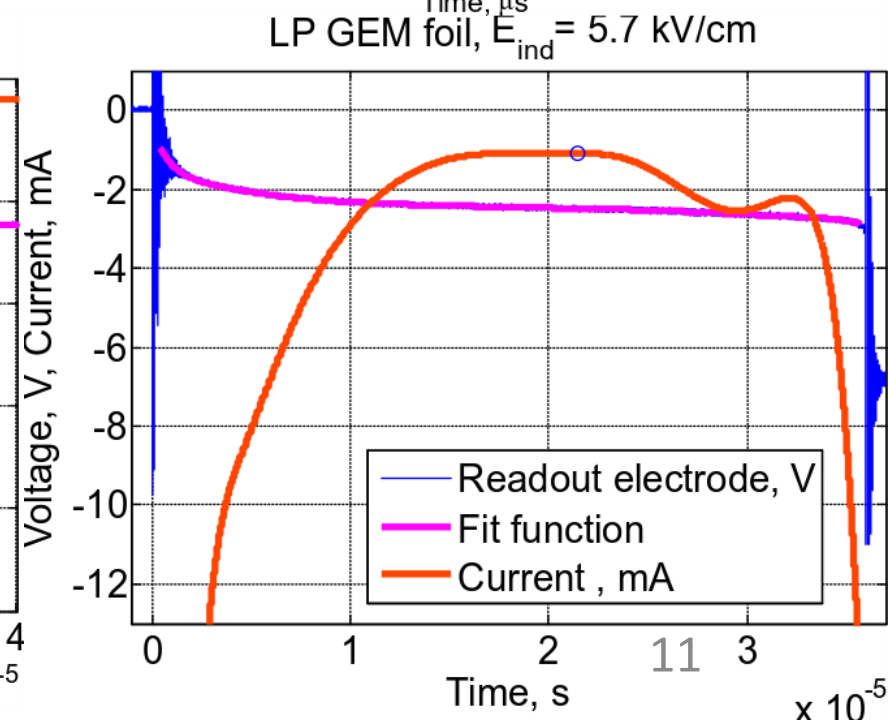
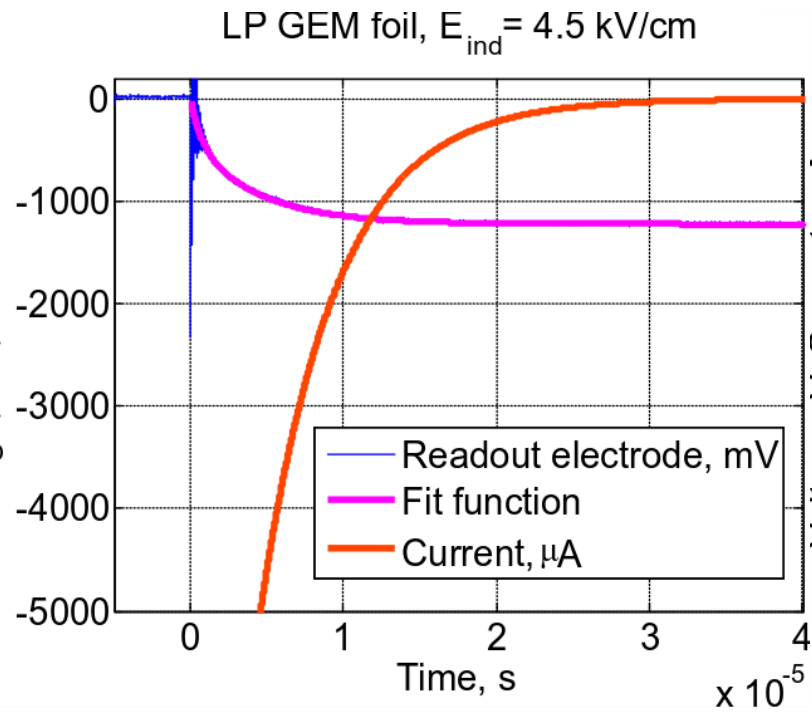
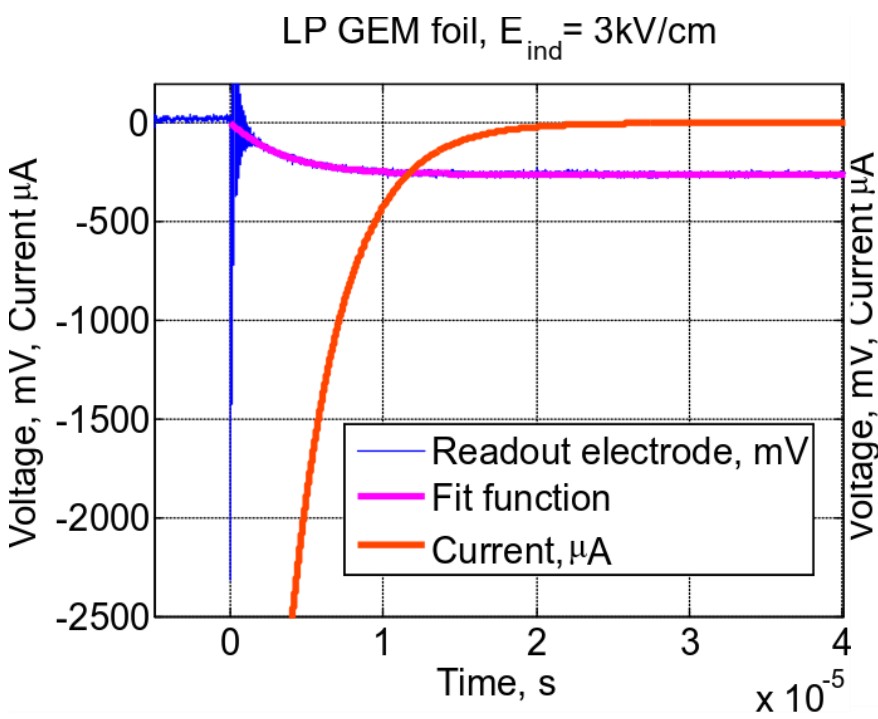
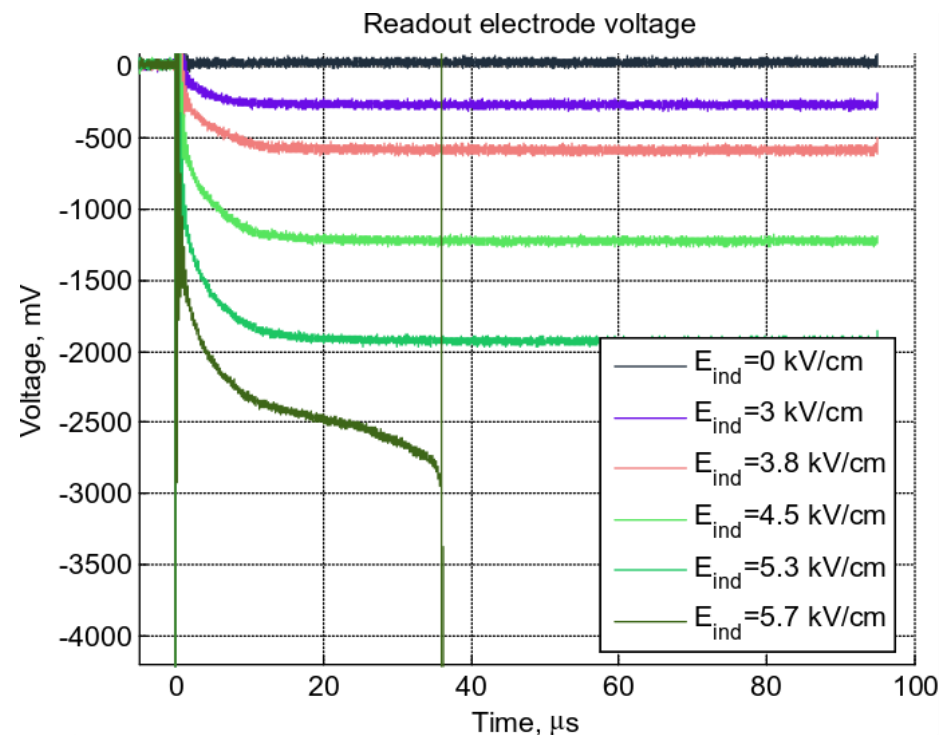

High speed camera measurements (GEM)

GEM @ $E_{ind} = 5.66$ kv/cm, $\Delta V_{GEM} = 500$ V, $R_{dec} = 0$ k Ω

PHOTRON SA-X2: 80x256, 300000 fps, S:1/583784, A:F2.8@100 mm

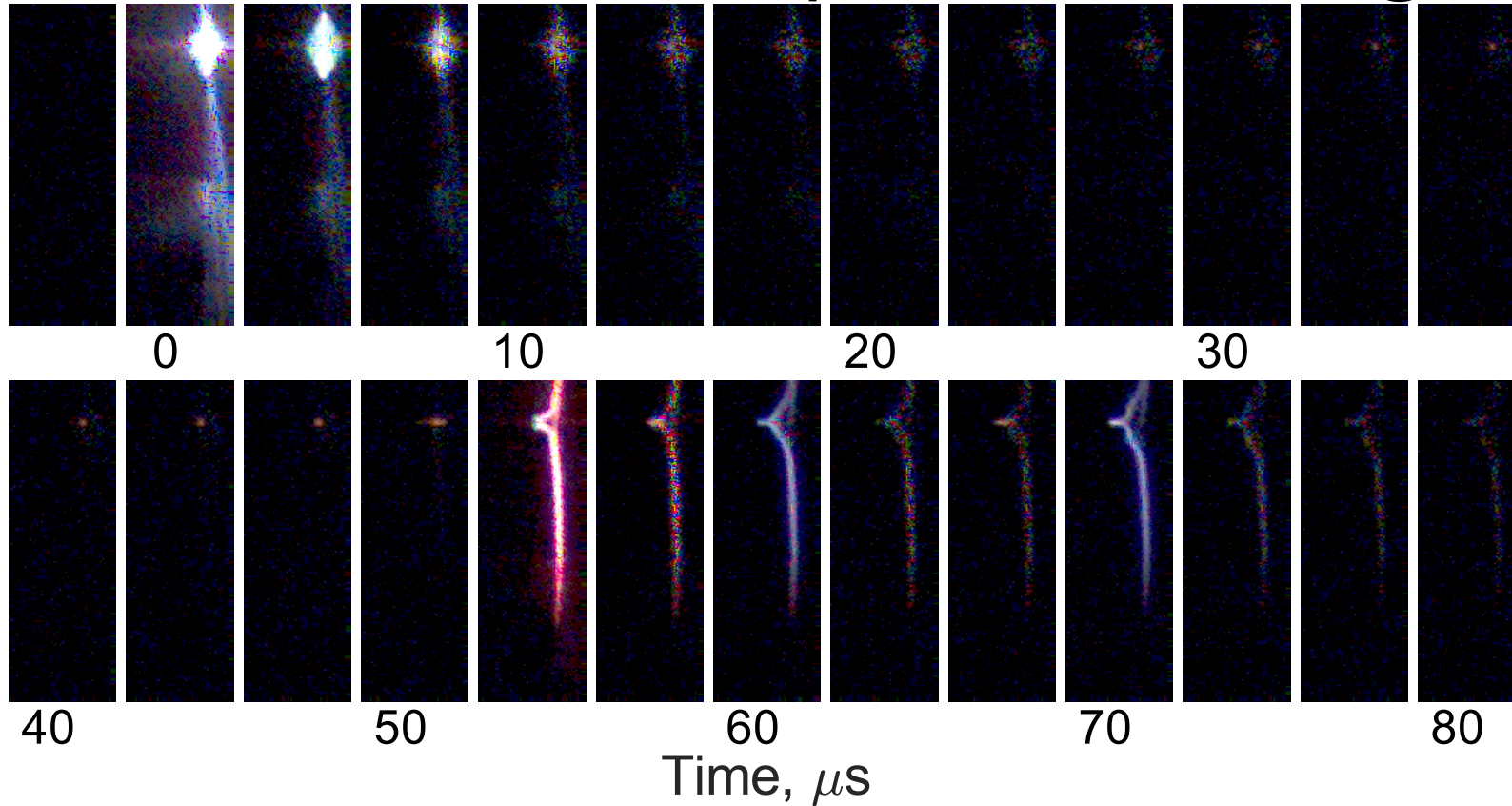

256 x 80
-0.013333 ms

Change of the glow spot intensity with time

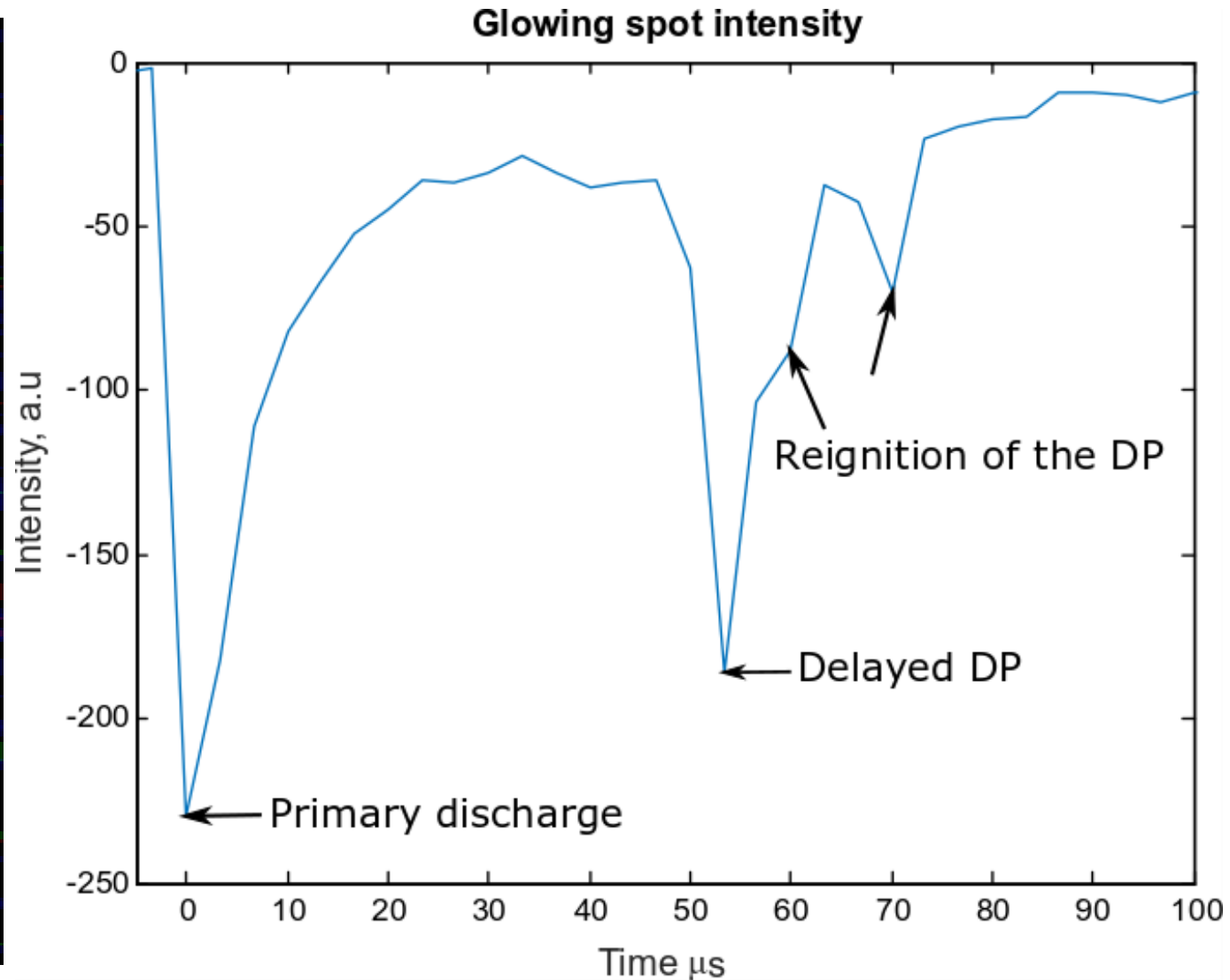
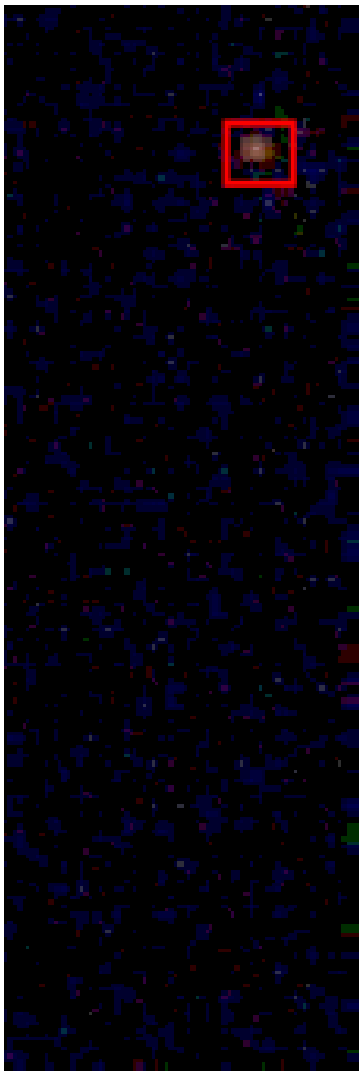

Correlated high speed camera measurements with recorded waveforms

GEM @ $E_{\text{ind}}=5.66$ kv/cm, $\Delta V_{\text{GEM}}=500$ V, $R_{\text{dec}}=0$ k Ω PHOTRON SA-X2: 80x256, 300000 fps, S:1/583784, A:F2.8@100 mm

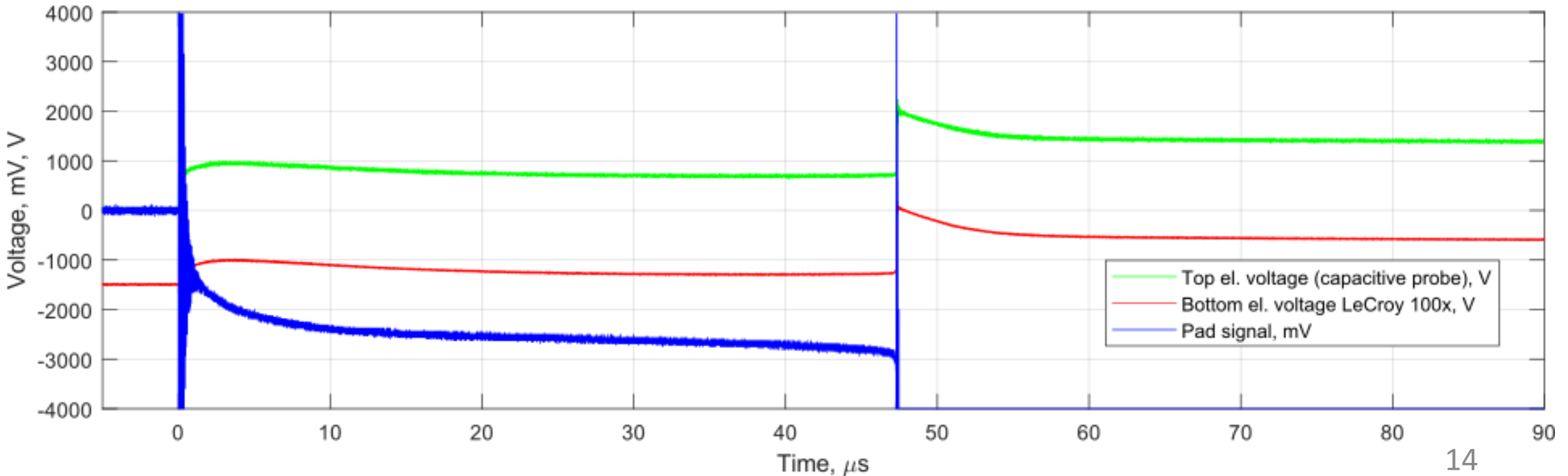
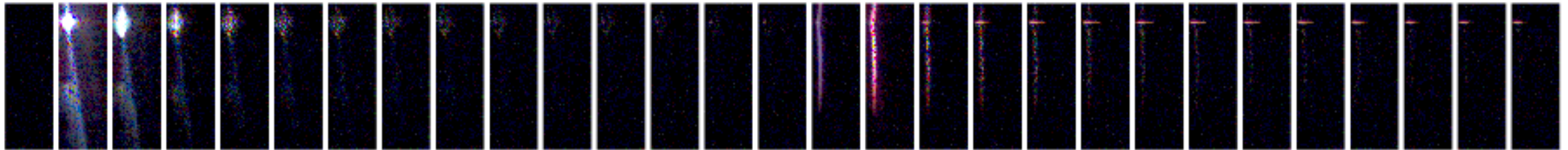

Glowing spot intensity vs. current correlation

- The correlation reveals that the optical intensity of the glow follows the waveform of the current.
- This proves that induction current originates from the glow at the bottom GEM electrode.
- All three regimes that precede the DP can be identified both in the optical and electrical measurements:
 - 1) Initial current decay after the primary,
 - 2) Constant current regime,
 - 3) Pre delayed current rise.
- The constant current regime is indicator of the occurrence of the delayed DP.

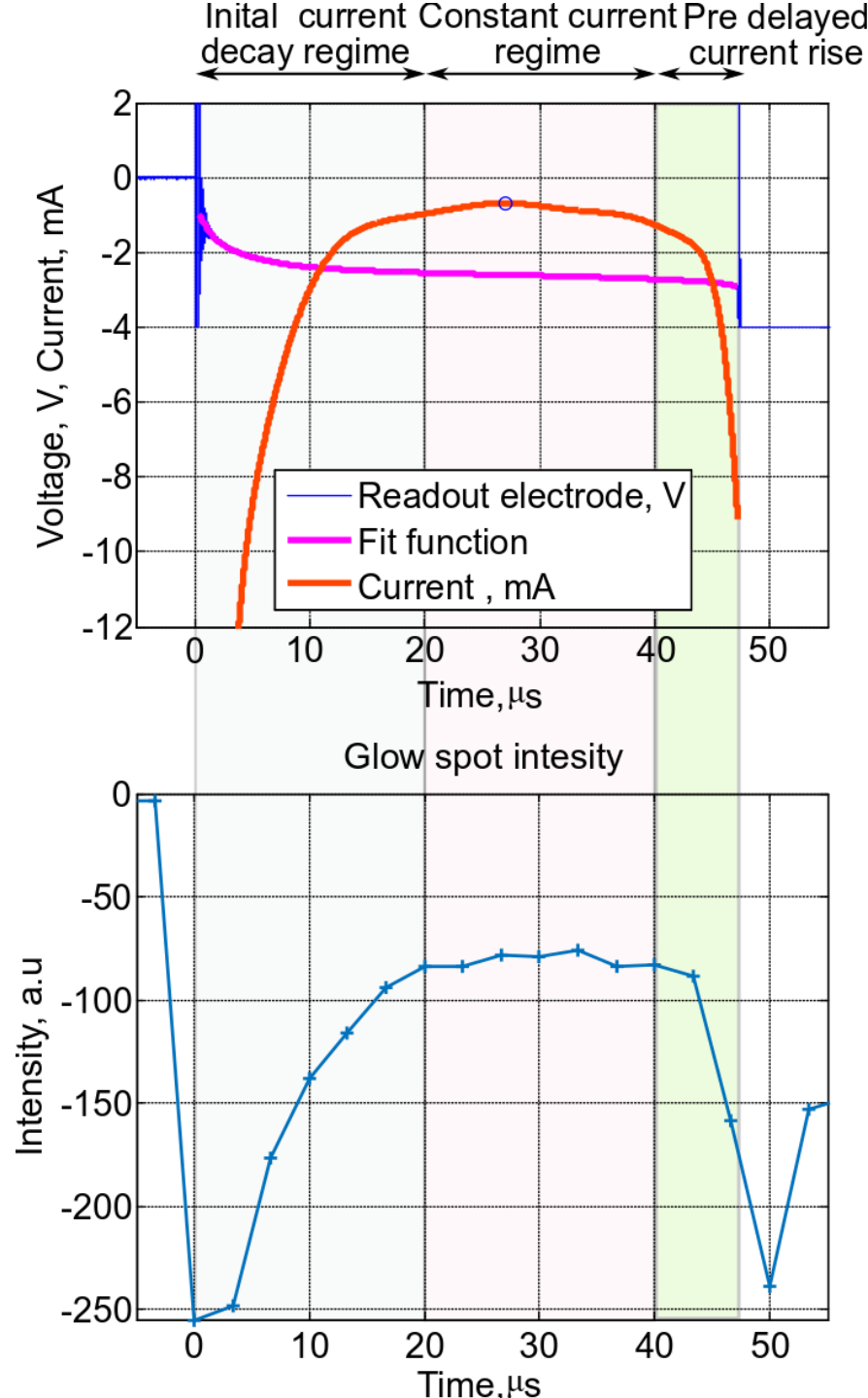

Conclusion

- A current in the induction region is observed between primary and delayed DP, for both single hole THGEM and LP GEM foils.
- To obtain the information about the current a smooth fit of the measured charge build-up on the readout electrode is needed.
- It has been observed that the induction current is in mA range decays to zero in case of no delayed DP.
- High-speed optical measurements reveal valuable information correlated with electrical measurements, mainly a glowing spot on the GEM bottom.
- The constant current region that appears after the decay can be optically related to the observed glow from GEM bottom.
- It has been show that current waveform correlates with the waveform of the intensity obtained from the high speed measurements.
- Three different current regimes that precede the delayed DP are identified (initial current decay, constant current regime and pre-delay current rise).
- Constant current region can be explained with the sustained glow caused by the heated cathode (thermionic emission).
- Thermionic emission generates even more heat due to the positive feedback effect.
- If heat cannot be removed (conduction/radiation) quickly enough, a thermal instability (runaway) of the glowing spot happens which results in the transition to arc.
- Introduction of the heat in the mechanichm of the delayed DP occurence explains the delay in μs range.

Thank you for your attention

Back up slide

